



RFLM-300511QA-392

Quasi Active High Power VHF & UHF Band Limiter Module

Features:

- Frequency Range: 30 MHz to 512 MHz
- Peak Power Handling: +60 dBm
- Average Power Handling: +56 dBm
- Low Insertion Loss: <0.7 dB
- Return Loss: <13 dB
- Low Flat Leakage Power: <19 dBm
- SMT Module: 10mm x 6mm x 2.5mm
- No external control lines or power supply required
- RoHS Compliant

Description:

The RFLM-300511QA-392 SMT Silicon PIN Diode Limiter Module offers both High Power CW and Peak protection in the VHF & UHF Band region. It is based on a proven hybrid assembly technique utilized extensively in high reliability, mission critical applications. The RFLM-300511QA-392 offers excellent thermal characteristics in a compact, low profile 10.6mm x 6.2mm x 2.5mm package. The RFLM-300511QA-392 is designed for optimal small signal insertion loss permitting extremely low receiver noise figure while simultaneously offering excellent large input signal Flat Leakage for effective receiver protection in the VHF and UHF Band frequency range. There are no on-board DC blocking capacitors, these must be provided off-board.

The limiter RF circuit characteristics provide outstanding passive receiver protection (Always On) which protects against High Average Power up to +56 dBm, High Peak Power up to +60 dBm pulsed, and maintains low Flat Leakage to less than 19 dBm.

ESD and Moisture Sensitivity Rating

The RFLM300511QC-392 Limiter Module carries a Class 0 ESD rating (HBM) and an MSL 1 moisture rating.

Thermal Management Features

The RFLM-300511QA-392 based substrate has been design to offer superior long term reliability in the customer's application by utilizing ultra-thin Au plating to combat Au embrittlement concerns. Also, a proprietary design methodology has minimized the thermal resistance from the PIN Diode junction to base plate. The two stage limiter design employs a second stage Schottky and quarter wavelength spacer detector circuit which

permits ultra-fast turn on of the High Power PIN Diodes. This circuit topology coupled with the thermal characteristic of the substrate design enables reliably handling High Input RF Power up to +56 dBm CW and RF Peak Power levels up to +60 dBm (25 usec pulse width @ 10% duty cycle with base plate temperature at +75°C).

Absolute Maximum Ratings

@ $Z_0=50\Omega$, $T_A=+25^\circ\text{C}$ as measured on the base ground surface of the device.

Parameter	Conditions	Absolute Maximum Value
Operating Temperature		-65°C to 125°C
Storage Temperature		-65°C to 150°C
Junction Temperature		175°C
Assembly Temperature	T = 30 seconds	260°C
RF Peak Incident Power	$T_{\text{CASE}}=75^\circ\text{C}$, source and load VSWR < 1.2, RF Pulse width = 25 usec, duty cycle = 10%, derated linearly to 0 W at $T_{\text{CASE}}=150^\circ\text{C}$ (See note 1)	+60 dBm
RF CW Incident Power		+56 dBm

Note 1: T_{CASE} is defined as the temperature of the bottom ground surface of the device.

RFLM-300511QA-392 Electrical Specifications

@ $Z_0=50\Omega$, $T_A=+25^\circ\text{C}$ as measured on the base ground surface of the device.

Parameters	Symbol	Test Conditions	Min Value	Typ Value	Max Value	Units
Frequency	F	$30\text{ MHz} \leq F \leq 512\text{ MHz}$	30		512	MHz
Insertion Loss	IL	$P_{\text{in}} = -20\text{ dBm}$, $F = 30 - 512\text{ MHz}$		0.3	0.7	dB
Insertion Loss Rate of Change vs Operating Temperature	ΔIL	$300\text{ MHz} \leq F \leq 512\text{ MHz}$, $P_{\text{in}} \leq -20\text{ dBm}$		0.005		dB/°C
Return Loss	RL	$P_{\text{in}} = -20\text{ dBm}$, $F = 30 - 512\text{ MHz}$		22	13	dB
Input 1 dB Compression Point	$\text{IP}_{1\text{dB}}$	$30\text{ MHz} \leq F \leq 512\text{ MHz}$		12		dBm
2 nd Harmonic	$2F_o$	$P_{\text{in}} = 0\text{ dBm}$, $F_o = 300\text{ MHz}$		-45		dBc
Peak Incident Power	$P_{\text{inc(PK)}}$	RF Pulse = 25 usec, duty cycle = 10%, $t_{\text{rise}} \leq 2\text{ us}$, $t_{\text{fall}} \leq 2\text{ usec}$			60	dBm
CW Incident Power	$P_{\text{inc(CW)}}$	$30\text{ MHz} \leq F \leq 512\text{ MHz}$			56	dBm
Flat Leakage	FL	$P_{\text{in}} = 60\text{ dBm}$, RF Pulse width = 25 usec, duty cycle = 10%, $t_{\text{rise}} \leq 2\text{ us}$, $t_{\text{fall}} \leq 2\text{ us}$		19		dBm
Spike Leakage Energy	SLE	$P_{\text{in}} = 60\text{ dBm}$, RF Pulse width = a5 us, duty cycle = 10%		0.5		erg
Recovery Time	T_R	50% falling edge of RF Pulse to 1 dB IL, $P_{\text{in}} = 60\text{ dBm}$ peak, RF PW = 25 us, duty cycle = 10%, $t_{\text{rise}} \leq 2\text{ us}$, $t_{\text{fall}} \leq 1\text{ usec}$		7.0		usec

Small Signal Performance: Return Loss & Insertion Loss

10 May 2021 10:56:10

CH1 S11 LOG 10 dB/REF 0 dB 1:-38.723 dB 10.000 000 MHz
CH2 S22 LOG 10 dB/REF 0 dB 1:-36.566 dB 10.000 000 MHz

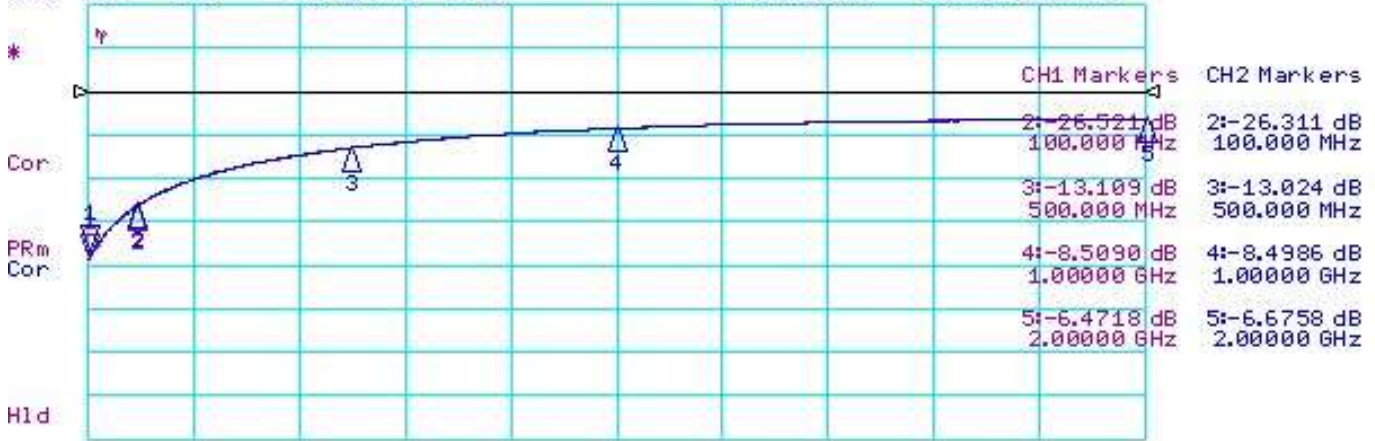

CH3 S21 LOG .5 dB/REF 0 dB 1:-.17060 dB 10.000 000 MHz
CH4 S12 LOG .5 dB/REF 0 dB 1:-.16100 dB 10.000 000 MHz

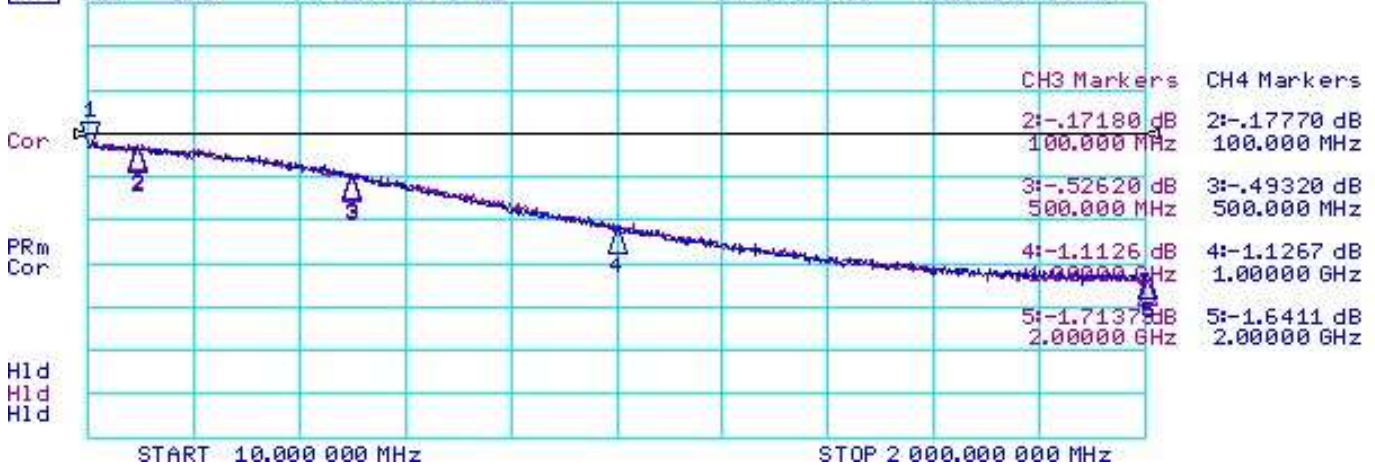

Note: Small Signal data taken without DC Blocking capacitors

Assembly Instructions

The RFLM-300511QA-392 may be attached to the printed circuit card using solder reflow procedures using either RoHS or Sn63/ Pb37 type solders per the Table and Temperature Profile Graph shown below:

Profile Parameter	Sn-Pb Assembly Technique	RoHS Assembly Technique
Average ramp-up rate (T_L to T_P)	3°C/sec (max)	3°C/sec (max)
Preheat		
Temp Min (T_{smin})	100°C	100°C
Temp Max (T_{smax})	150°C	150°C
Time (min to max) (t_s)	60 – 120 sec	60 – 120 sec
T_{smax} to T_L		
Ramp up Rate		3°C/sec (max)
Peak Temp (T_P)	225°C +0°C / -5°C	260°C +0°C / -5°C
Time within 5°C of Actual Peak Temp (T_P)	10 to 30 sec	20 to 40 sec
Time Maintained Above:		
Temp (T_L)	183°C	217°C
Time (t_L)	60 to 150 sec	60 to 150 sec
Ramp Down Rate	6°C/sec (max)	6°C/sec (max)
Time 25°C to T_P	6 minutes (max)	8 minutes (max)

Solder Re-Flow Time-Temperature Profile

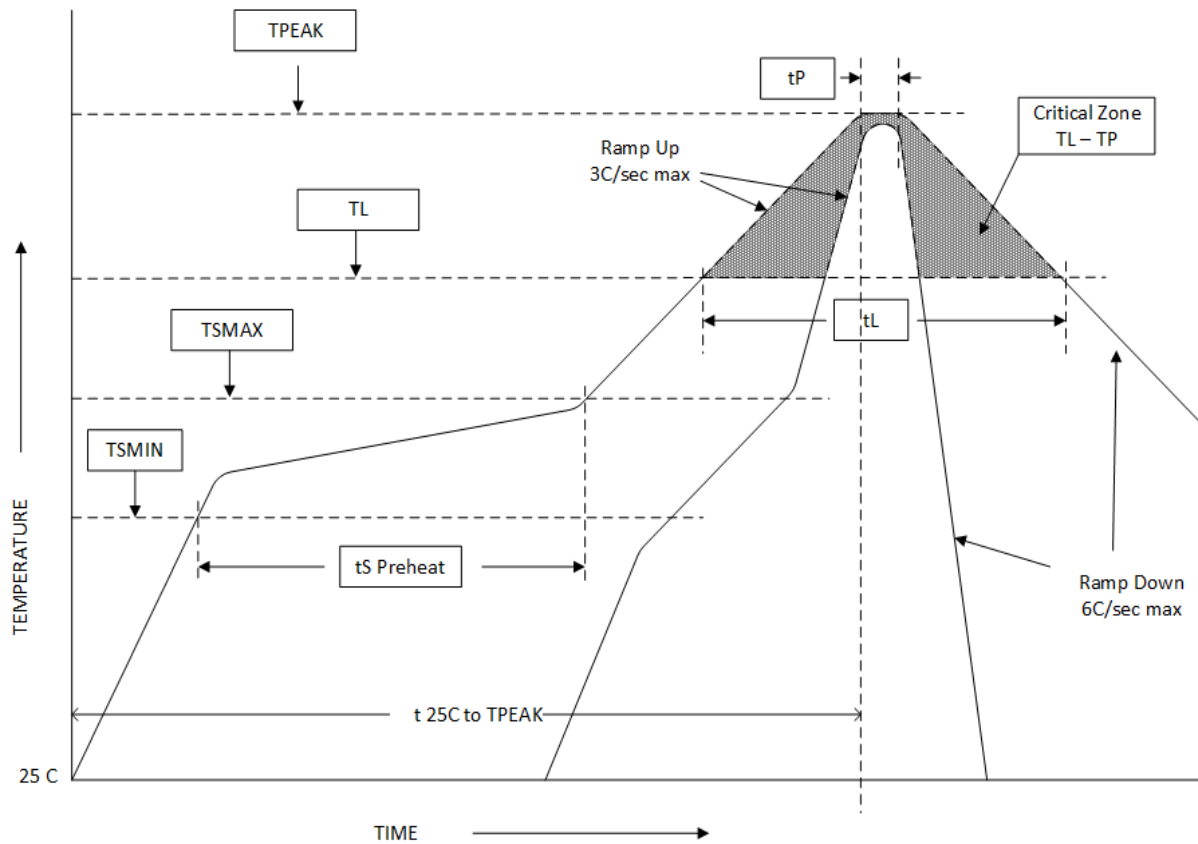

RFLM-300511QA-392 Limiter Module Package Outline Drawing

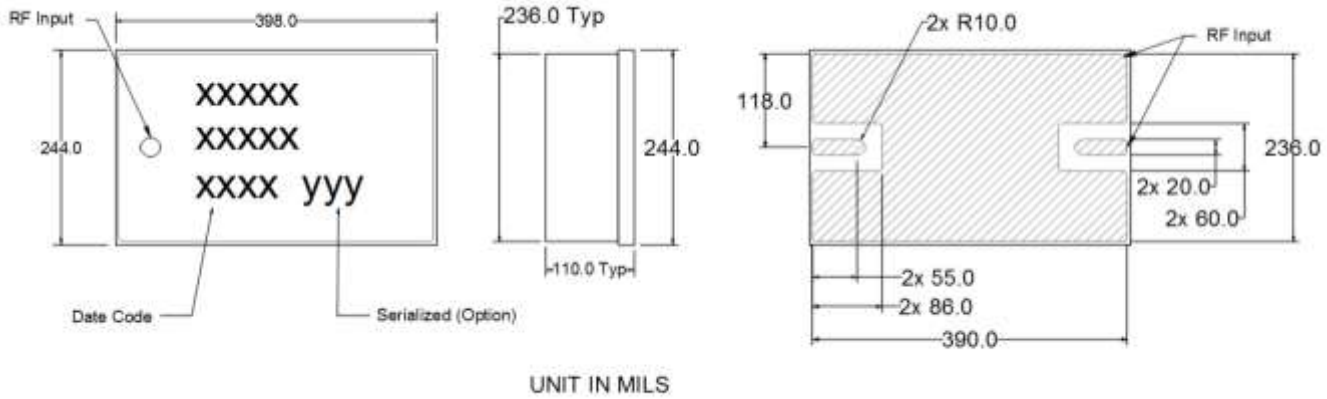

Notes:

- 1) Metalized area on backside is the RF, DC and Thermal ground. In user's end application this surface temperature must be managed to meet the power handling requirements.
- 2) Back side metallization is thin Au termination plating to combat Au embrittlement (Au plated over Cu).

Thermal Design Considerations:

The design of the RFLM-300511QA-392 Limiter Module permits the maximum efficiency in thermal management of the PIN Diodes while maintaining extremely high reliability. Optimum Limiter performance and reliability of the device can be achieved by the maintaining the base ground surface temperature of less than 75°C.

There must be a minimal thermal and electrical resistance between the limiter bottom surface and ground. Adequate thermal management is required to maintain a T_{JC} at less than +175°C and thereby avoid adversely affecting the semiconductor reliability. Special care must be taken to assure that minimal voiding occurs in the solder connection in the area shaded in red in the figure shown below:

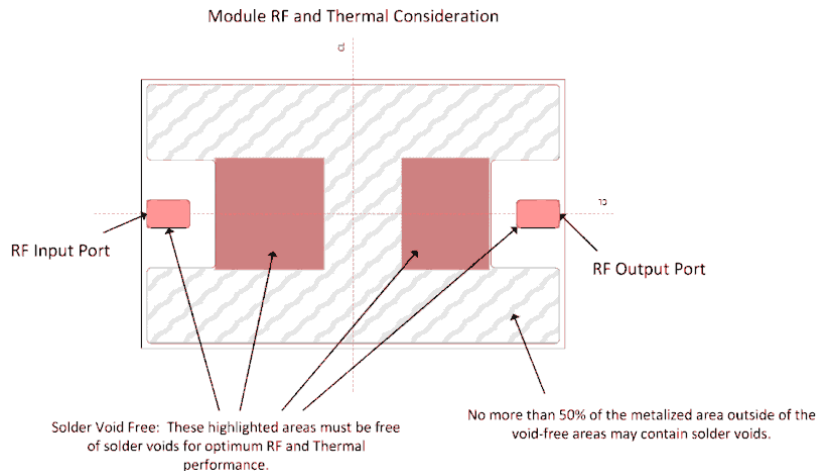

It is recommended that a low thermal impedance path be established between the base plate of the Limiter and the heat sink below. This can be achieved via the use of a copper embedded coin in the user's PCB design or via the use of a pedestal mounting technique (shown below) which permits a direct attachment of the Limiter's base plate to the heat sink below.

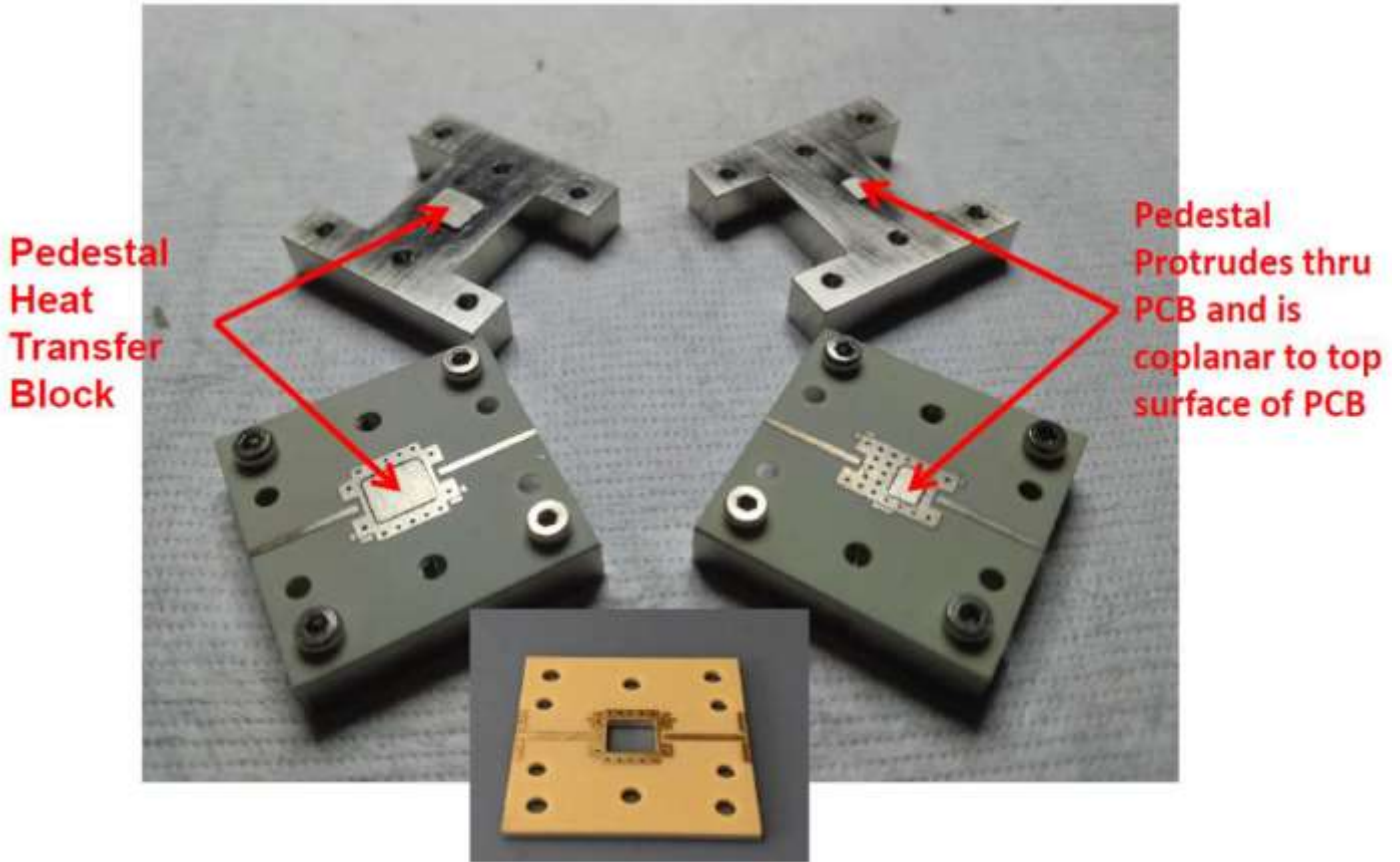

In cases where this is not possible, the foot print below may be used but the user's must account for proper power handling derating based on the maximum base plate temperature as outlined in the Absolute Maximum Rated table.

RF Circuit Solder Footprint for the RFLM-300511QA-392

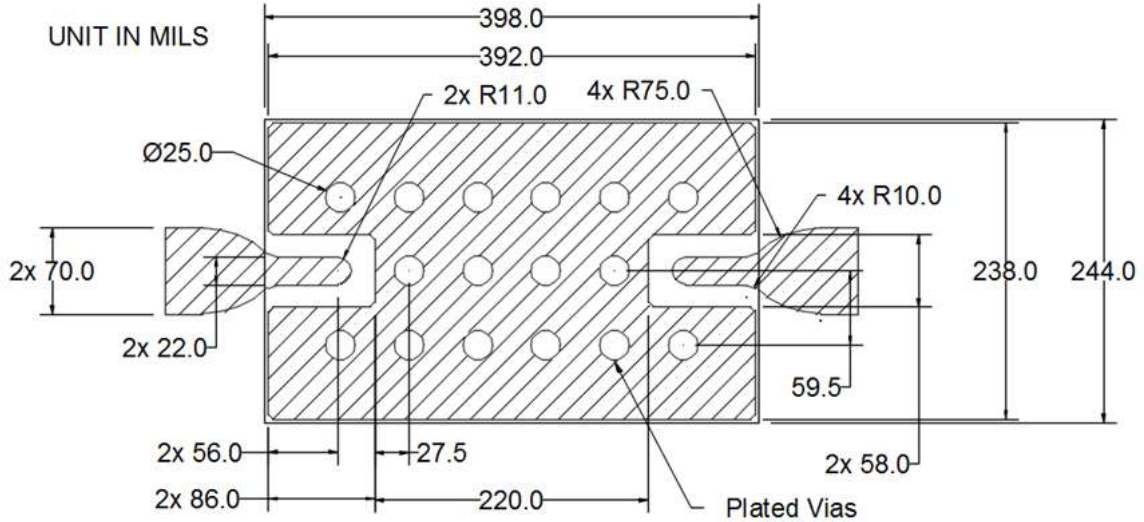

Low Signal PCB Layout Recommendation. Microstrip transmission line is based on Rogers 4003C, 32 mils, 1 oz copper. Plated vias are only sufficient for low signal evaluation.

Notes:

- 1) Recommended PCB material is Rogers 4350B, 20 mils thick (RF Input and Output trace width needs to be adjusted from the recommended footprint.)
- 2) Foot print is suggested for low level signal application. High power applications require device to be mounted directly to an adequate heat. Please contact the factory for assistance.
- 3) Hatched area is RF, DC and Thermal Ground.

Part Number Ordering Detail:

The RFLM-300511QA-392 Limiter Module is available in the following format:

Part Number	Description	Packaging
RFLM-300511QA-392	VHF & UHF Band Limiter	Gel-Pack
RFLM-300511QA-392 SS EVB	RFLM-300511QA-392 Small Signal Evaluation Board	Box
RFLM-300511QA-392 HP EVB	RFLM-300511QA-392 High Power Evaluation Board	Box