



RFLM-202802Qx-290

Two Stage Quasi-Active Wide Band Limiter Module

Features:

- Frequency Range: 2 GHz to 8 GHz
- High Peak Power Handling: +60 dBm
- High Average Power Handling: +50 dBm
- Low Insertion Loss: <1.1 dB
- Return Loss: >13 dB
- Low Flat Leakage Power: <21 dBm
- Low Spike Energy Leakage: <0.5 ergs
- Surface Mount Limiter Module: 8mm x 5mm x 2.5mm
- Optional DC Coupling Capacitors
- No external control lines or power supply required
- RoHS Compliant

Description:

The RFLM-202802Qx-290 SMT Silicon PIN Diode Limiter Module offer both High Peak Power and High Average Power protection in the 2 GHz to 8 GHz frequency range. It is based on proven hybrid assembly techniques utilized extensively in high reliability, mission critical applications. The RFLM-202802Qx-290 offers excellent thermal characteristics in a compact, low profile 8mm x 5mm x 2.5mm SMT package. The RFLM-202802Qx-290 is designed for optimal small signal insertion loss permitting extremely low receiver noise figure while simultaneously offering excellent large input signal Flat Leakage for effective receiver protection in the 2 GHz to 8 GHz frequency range.

The RFLM-202802Qx-290 Limiter Module provides outstanding passive receiver protection (always on) which protects against High Peak Power up to +60 dBm pulsed and High Average Power up to +50 dBm while maintaining low flat leakage to less than +21 dBm, and reduces Spike Leakage to less than 0.5 ergs.

ESD and Moisture Sensitivity Rating

The RFLM-202802Qx-290 Limiter Module carries a Class 1 ESD rating (HBM) and an MSL 1 moisture rating.

Thermal Management Features

The RFLM-202802Qx-290 based substrate has been design to offer superior long term reliability in the customer's application by utilizing ultra-thin Au plating to combat Au embrittlement concerns. Also, a proprietary design methodology has minimized the thermal resistance from the PIN Diode junction to base plate (R_{THJ-A}).

The two stage limiter design employs a second stage Schottky and quarter wavelength spacer detector circuit which permits ultra-fast turn on of the High Power PIN Diodes. This circuit topology coupled with the thermal characteristic of the substrate design enables reliably handling High Input RF Power up to +50 dBm CW and RF Peak Power levels up to +60 dBm (7 uSec pulse width @ 5% duty cycle with base plate temperature at +55°C).

Optional RF Coupling Capacitors

The RFLM-202802Qx-290 is offered in three different configurations: no RF coupling capacitors (x=A), a single input RF coupling capacitor (x=B), or both input & output RF coupling capacitors (x=C) as is show in the three options below:

RFLM-202802QA-290 Limiter Module Schematic - No RF Coupling Capacitors

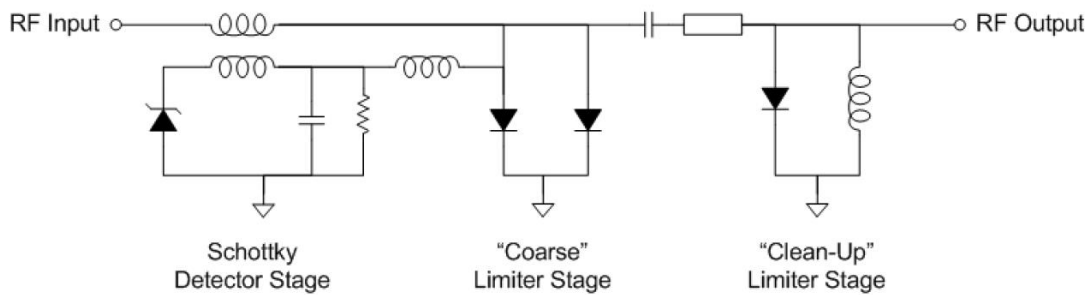

RFLM-202802QB-290 Limiter Module Schematic - RF Input Coupling Capacitors

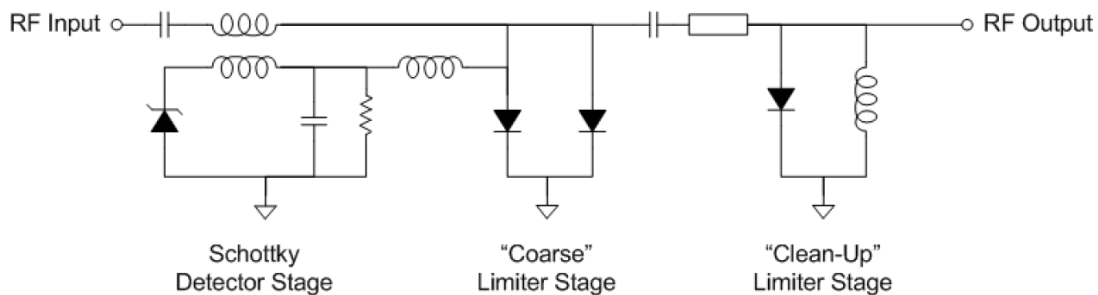

RFLM-202802QC-290 Limiter Module Schematic - RF Input & Output Coupling Capacitors

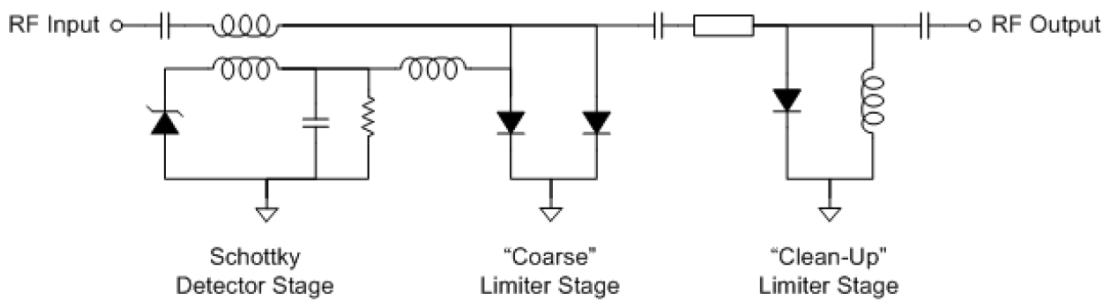

Absolute Maximum Ratings

@ $Z_0=50\Omega$, $T_A=+25^\circ\text{C}$ as measured on the base ground surface of the device.

Parameter	Conditions	Absolute Maximum Value
Operating Temperature		-65°C to 125°C
Storage Temperature		-65°C to 150°C
Junction Temperature		175°C
Assembly Temperature	T = 30 seconds	260°C
RF Peak Incident Power	$T_{\text{CASE}}=+55^\circ\text{C}$, source and load VSWR < 1.2, RF Pulse width = 7 usec, duty cycle = 5%, derated linearly to 0 W at $T_{\text{CASE}}=+150^\circ\text{C}$ (See note 1)	+60 dBm
RF CW Incident Power	$T_{\text{CASE}}=+55^\circ\text{C}$, source and load VSWR < 1.2, derated linearly to 0 W at $T_{\text{CASE}}=+150^\circ\text{C}$ (See note 1)	+50 dBm
RF Input & Output DC Block Capacitor Voltage Breakdown		100 V DC

Note 1: T_{CASE} is defined as the temperature of the bottom ground surface of the device.

RFLM-202802QX-290 Electrical Specifications

@ $Z_0=50\Omega$, $T_A=+25^\circ\text{C}$ as measured on the base ground surface of the device.

Parameters	Symbol	Test Conditions	Min Value	Typ Value	Max Value	Units
Frequency	F	$2\text{ GHz} \leq F \leq 8\text{ GHz}$	2		8	GHz
Insertion Loss	IL	$2\text{ GHz} \leq F \leq 8\text{ GHz}$, $P_{\text{in}} = -20\text{ dBm}$		0.7	1.1	dB
Insertion Loss Rate of Change vs Operating Temperature	ΔIL	$2\text{ GHz} \leq F \leq 8\text{ GHz}$, $P_{\text{in}} \leq -20\text{ dBm}$		0.005		dB/°C
Return Loss	RL	$2\text{ GHz} \leq F \leq 8\text{ GHz}$, $P_{\text{in}} = -20\text{ dBm}$	13			dB
Input 1 dB Compression Point	$\text{IP}_{1\text{dB}}$	$2\text{ GHz} \leq F \leq 8\text{ GHz}$		10		dBm
2 nd Harmonic	$2F_0$	$P_{\text{in}} = 0\text{ dBm}$, $F_0 = 2.0\text{ GHz}$	45	50		dBc
Peak Incident Power	$P_{\text{inc(PK)}}$	RF Pulse = 7 usec, duty cycle = 5%, $t_{\text{rise}} \leq 2\text{ us}$, $t_{\text{fall}} \leq 2\text{ usec}$			60	dBm
CW Incident Power	$P_{\text{inc(CW)}}$	$1\text{ GHz} \leq F \leq 2\text{ GHz}$			50	dBm
Flat Leakage	FL	$P_{\text{in}} = 60\text{ dBm}$, RF Pulse width = 7 us, duty cycle = 5%, $t_{\text{rise}} \leq 2\text{ us}$, $t_{\text{fall}} \leq 2\text{ us}$		21		dBm
Spike Leakage	SL	$P_{\text{in}} = 60\text{ dBm}$, RF Pulse width = 7 us, duty cycle = 5%			0.5	erg
Recovery Time	T_R	50% falling edge of RF Pulse to 1 dB IL, $P_{\text{in}} = 50\text{ dBm}$ peak, RF PW = 7 us, duty cycle = 5%, $t_{\text{rise}} \leq 2\text{ us}$, $t_{\text{fall}} \leq 1\text{ usec}$			5	usec

RFLM-202802QC-290 Typical Performance

$Z_0 = 50\Omega$, $T_{CASE} = +25^\circ C$ as measured on the Ground Plane of the device, PIN = -20 dBm.

RFLM-202802QC-290 Insertion Loss vs Frequency

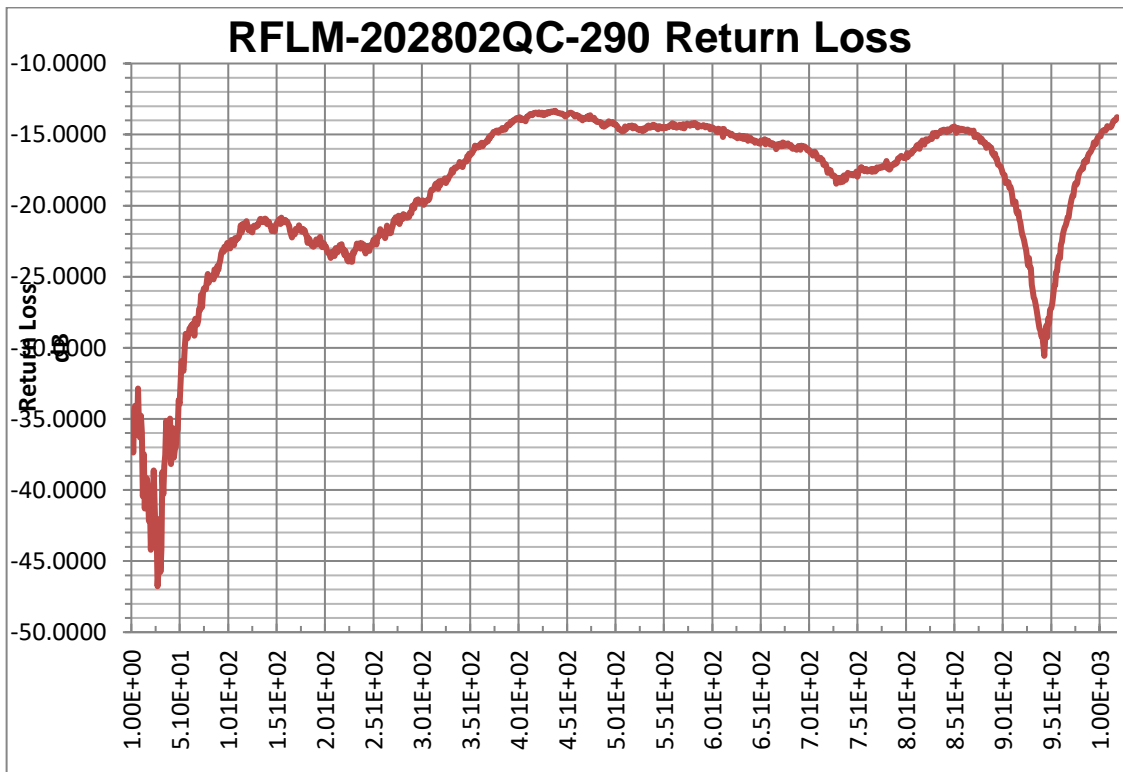
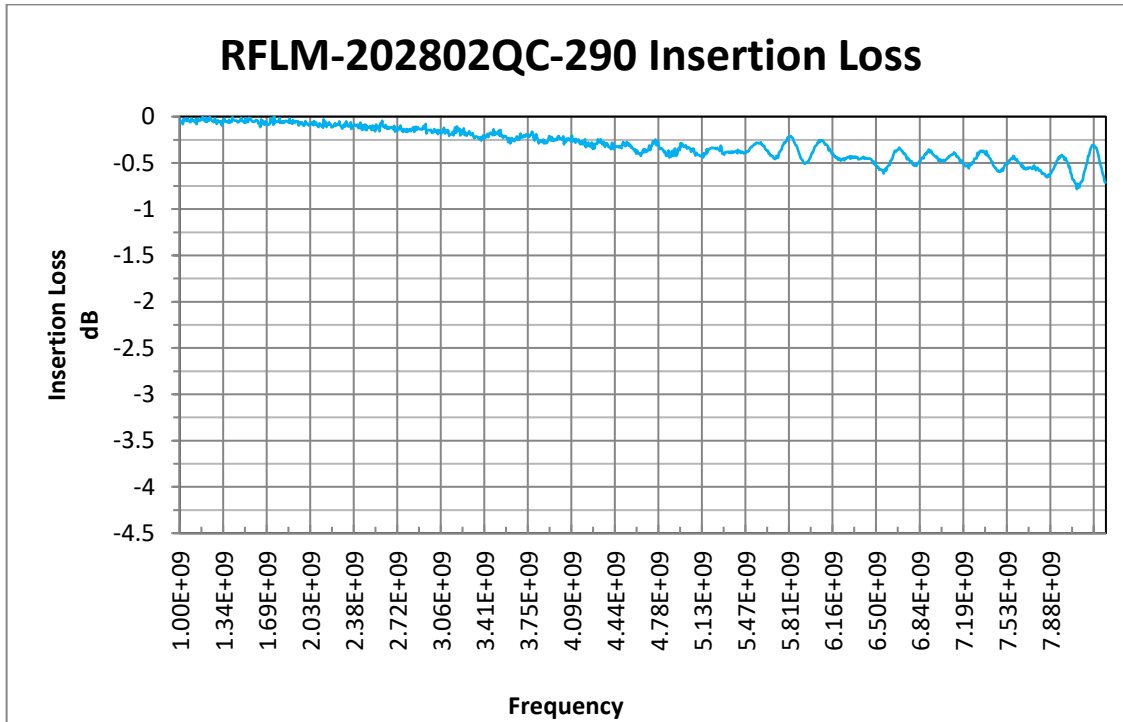

RFLM-202802QC-290 Flat Leakage CW Power Output vs CW Input Output

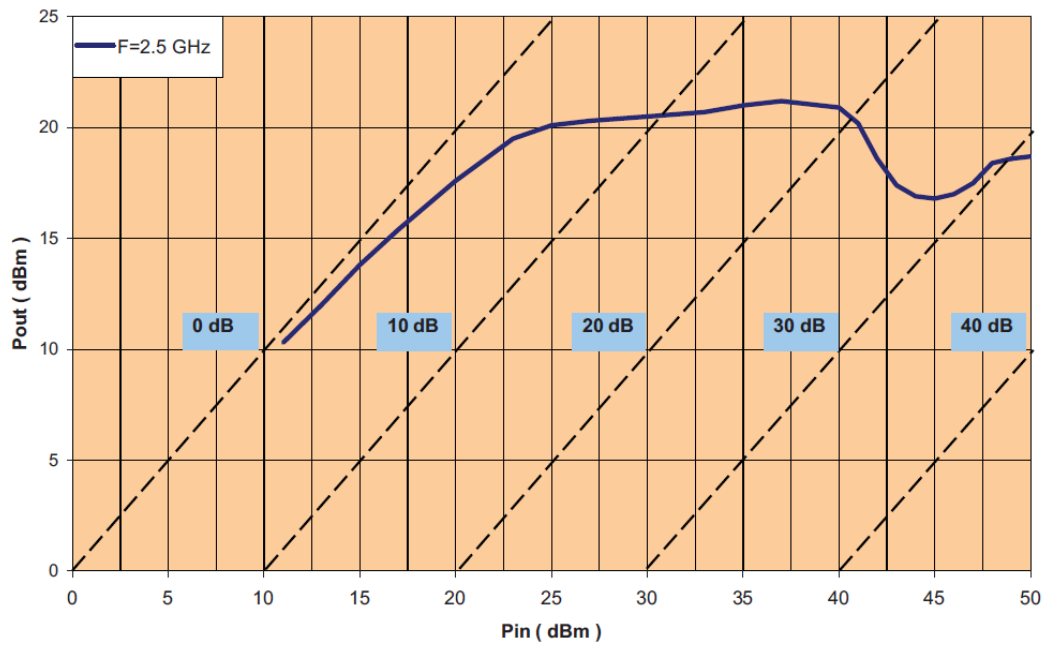

Assembly Instructions

The RFLM-202802Qx-290 may be attached to the printed circuit card using solder reflow procedures using either RoHS or Sn63/ Pb37 type solders per the Table and Temperature Profile Graph shown below:

Profile Parameter	Sn-Pb Assembly Technique	RoHS Assembly Technique
Average ramp-up rate (T_L to T_P)	3°C/sec (max)	3°C/sec (max)
Preheat		
Temp Min (T_{smin})	100°C	100°C
Temp Max (T_{smax})	150°C	150°C
Time (min to max) (t_s)	60 – 120 sec	60 – 120 sec
T_{smax} to T_L		
Ramp up Rate		3°C/sec (max)
Peak Temp (T_P)	225°C +0°C / -5°C	245°C +0°C / -5°C
Time within 5°C of Actual Peak Temp (T_P)	10 to 30 sec	20 to 40 sec
Time Maintained Above: Temp (T_L) Time (t_L)	183°C 60 to 150 sec	217°C 60 to 150 sec
Ramp Down Rate	6°C/sec (max)	6°C/sec (max)
Time 25°C to T_P	6 minutes (max)	8 minutes (max)

Solder Re-Flow Time-Temperature Profile

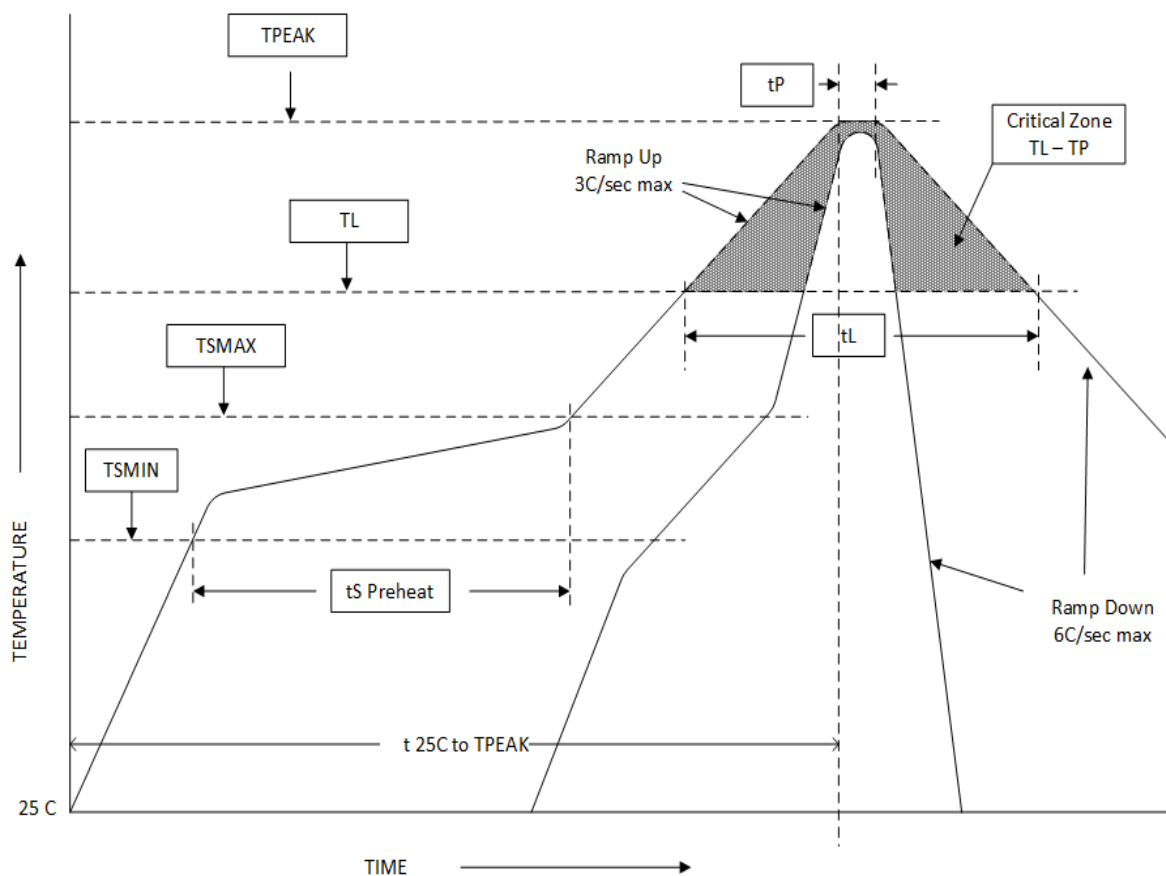

RFLM-202802Qx-290 Limiter Module Package Outline Drawing

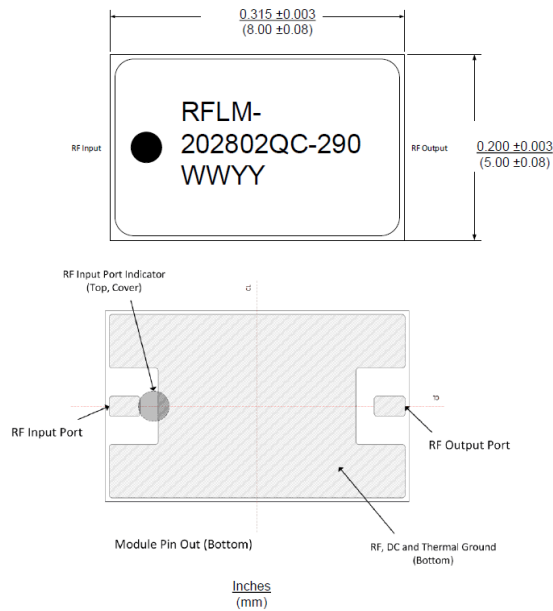

Notes:

- 1) Metalized area on backside is the RF, DC and Thermal ground. In user's end application this surface temperature must be managed to meet the power handling requirements.
- 2) Back side metallization is thin Au termination plating to combat Au embrittlement (15 u in typ Au plated over Ti-Pd).

Recommended RF Circuit Solder Footprint for the RFLM-202802Qx-290

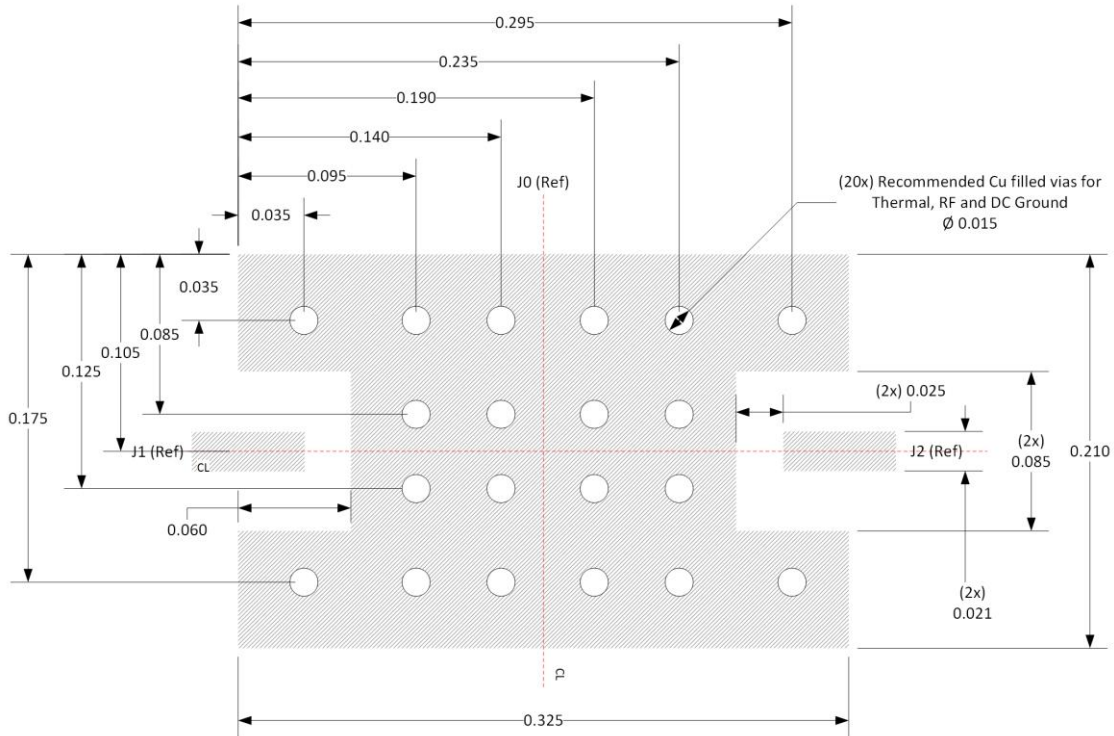

Notes:

- 1) Recommended PCB material is rogers 4350, 10 mils thick.
- 2) Hatched area is RF, DC and Thermal Ground. Vias should be solid Cu filled and Au plated for optimal heat transfer from backside of Limiter Module through circuit vias to thermal ground.

Thermal Design Considerations:

The design of the RFLM-202802Qx-290 family of Limiter Modules permits the maximum efficiency in thermal management of the PIN Diodes while maintaining extremely high reliability. Optimum Limiter performance and reliability of the device can be achieved by the maintaining the base ground surface temperature of less than +55°C.

There must be a minimal thermal and electrical resistance between the limiter and ground. Adequate thermal management is required to maintain T_{jc} at less than +175°C and thereby will not adversely affect the semiconductor reliability. Special care must be taken to assure that minimal voiding occurs in the solder connection in the areas shade in red in the figure shown below.

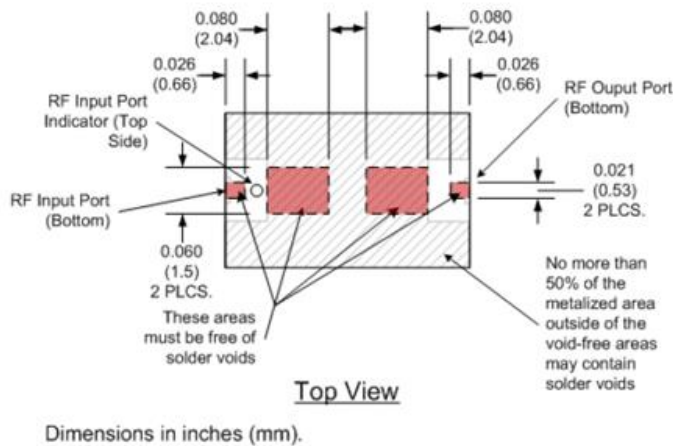

Part Number Ordering Detail:

The RFLM-202802Qx-290 Limiter Modules are available in the following shipping format:

Part Number	Description	Packaging
RFLM-202802QA-290	2 GHz to 8 GHz Band Limiter, No DC Blocking Capacitors	Gel-Pack
RFLM-202802QA-290 HP EVB	RFLM-202802QA-290 High Power Evaluation Board	Box
RFLM-202802QB-290	2 GHz to 8 GHz Band Limiter, Input Blocking Capacitors	Gel-Pack
RFLM-202802QB-290 HP EVB	RFLM-202802QB-290 High Power Evaluation Board	Box
RFLM-202802QC-290	2 GHz to 8 GHz Band Limiter, Input & Output DC Blocking Capacitors	Gel-Pack
RFLM-202802QC-290 HP EVB	RFLM-202802QC-290 High Power Evaluation Board	Box